

# JENSEN®

## Portable Docking CD Music System for iPod



**Owner's Manual**

**JiSS-115**

(iPod Not Included)

Please read this Instruction Manual carefully before using the unit and retain it for future reference



## WARNING:

TO REDUCE THE RISK OF FIRE OR ELECTRIC SHOCK, DO NOT EXPOSE THIS APPLIANCE TO RAIN OR MOISTURE. DANGEROUS HIGH VOLTAGES ARE PRESENT INSIDE THE ENCLOSURE. DO NOT OPEN THE CABINET REFER SERVICING TO QUALIFIED PERSONNEL ONLY.

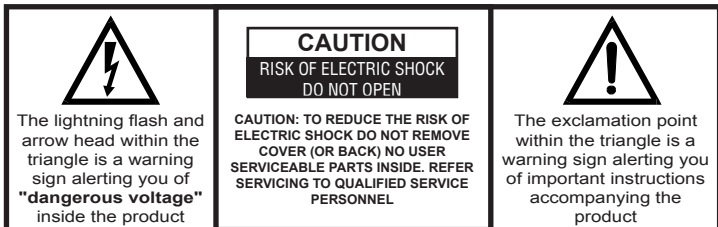

**The Caution marking is located at the bottom of the unit  
The rating plate is located at the back of the unit**

## CAUTION:

PLEASE READ AND OBSERVE ALL WARNINGS AND INSTRUCTIONS GIVEN IN THIS OWNER'S MANUAL AND THOSE MARKED ON THE UNIT, KEEP THESE INSTRUCTIONS. RETAIN THIS BOOKLET FOR FUTURE REFERENCE.

This set has been designed and manufactured to assure personal safety. Improper use can result in electric shock or fire hazard. The safeguards incorporated in this unit will protect you if you observe the following procedures for installation, use and servicing. This unit does not contain any parts that can be repaired by the user.



The symbol for class II (Double insulation)

**DO NOT REMOVE THE CABINET COVER, OR YOU MAY BE EXPOSED TO DANGEROUS VOLTAGE. REFER SERVICING TO QUALIFIED SERVICE PERSONNEL ONLY.**

## IMPORTANT SAFETY INSTRUCTIONS

1. Read these Instructions.
2. Keep these Instructions.
3. Heed all Warnings.
4. Follow all instructions.
5. Do not use this apparatus near water.
6. Clean only with a dry cloth.
7. Do not block any of the ventilation openings. Install in accordance with the manufacturer's instructions.
8. Do not install near any heat sources such as radiators, heat registers, stoves, or other apparatus (including amplifiers) that produce heat.



# IMPORTANT SAFETY INSTRUCTIONS (Continued)

- Do not defeat the safety purpose of the polarized or grounding – type plug. A polarized plug has two blades with one wider than the other. A grounding type plug has two blades and a third grounding prong. The wide blade or the third prong is provided for your safety. If the provided plug does not fit into your outlet, consult an electrician for replacement of the obsolete outlet.
- Protect the power cord from being walked on or pinched particularly at plugs, convenience receptacles and the point where they exit from the apparatus.
- Only use attachments/accessories specified by the manufacturer.
- Use only with a cart, stand, tripod, bracket, or table specified by the manufacturer, or sold with the apparatus. When a cart is used, use caution when moving the cart/apparatus combination to avoid injury from tip-over.
- Unplug this apparatus during lightning storms or when unused for long periods of time.
- Refer all servicing to qualified service personnel. Servicing is required when the apparatus has been damaged in anyway, such as power-supply cord or plug is damaged, liquid has been spilled or objects have fallen into the apparatus, the apparatus has been exposed to rain or moisture, does not operate normally, or has been dropped.
- The apparatus shall not be exposed to dripping or splashing and that no objects filled with liquids, such as vases, shall be placed on apparatus.
- Main plug is used as disconnect device and it should remain readily operable during intended use. In order to disconnect the apparatus from the mains completely, the mains plug should be disconnected from the mains socket outlet completely.
- Battery shall not be exposed to excessive heat such as sunshine, fire or the like.



## IMPORTANT NOTE

In case of malfunction due to electrostatic discharge, the apparatus has to be reset by disconnecting it from mains supply and removing all the batteries. Wait at least for 5 seconds before reconnect the AC power cord or reinstall the batteries.

## CAUTION:

**TO PREVENT ELECTRIC SHOCK, MATCH WIDE BLADE OF PLUG TO WIDE SLOT.  
FULLY INSERT.**

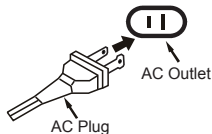



## WARNING

### CLASS 1 LASER PRODUCT

CLASS 1 LASER PRODUCT  
APPAREIL À LASER DE CLASSE 1  
PRODUCTO LASER DE CLASE 1

**CAUTION**  
INVISIBLE LASER RADIATION  
WHEN OPEN AND INTERLOCKS  
DEFEATED  
AVOID EXPOSURE TO BEAM



This product contains a low power laser device.

Follow the advice below for safe operations.

### ON PLACEMENT

- Do not use the unit in places which are extremely hot, cold, dusty, or humid.
- Place the unit on a flat and even surface.
- Do not restrict the air flow of the unit by placing it in a place with poor air flow, by covering it with a cloth, or by placing it on a carpet.

### ON SAFETY

- When connecting and disconnecting the AC cord, grip the plug and not the cord itself. Pulling the cord may damage it and create hazard.
- When you are not going to use the unit for a long period of time, disconnect the AC power cord and remove all batteries.

### ON AC VOLTAGE

- Before use, check that the rated voltage of your unit matches your local voltage.

### ON CONDENSATION

- When left in a heated room where it is warm and damp, water droplets or condensation may form inside the CD player.
- When there is condensation inside the unit, the unit may not function normally.
- Let it stand for 1 to 2 hours before turning the power on, or gradually heat the room up and dry the unit before use.

**Should any trouble occur, disconnect the AC power cord and refer servicing to qualified personnel.**





## FCC NOTICE

This equipment has been tested and found to comply with the limits for a Class B digital device, pursuant to Part 15 of the FCC Rules. These limits are designed to provide reasonable protection against harmful interference in a residential installation. This equipment generates, uses and can radiate radio frequency energy and, if not installed and used in accordance with the instructions, may cause harmful interference to radio communications.

However, there is no guarantee that interference will not occur in a particular installation. If this equipment does cause harmful interference to radio or television reception, which can be determined by turning the equipment off and on, the user is encouraged to try to correct the interference by one or more of the following measures:

- Reorient or relocate the receiving antenna.
- Increase the separation between the equipment and receiver.
- Connect the equipment into an outlet on a circuit different from that to which the receiver is needed.
- Consult the dealer or an experienced radio/TV technician for help.

### **WARNING:**

Changes or modifications to this unit not expressly approved by the party responsible for compliance could void the user's authority to operate the equipment.

## PROTECT YOUR FURNITURE!!

This system is equipped with non-skid rubber 'feet' to prevent the product from moving when you operate the controls. These 'feet' are made from non-migrating rubber material specially formulated to avoid leaving any marks or stains on your furniture. However certain types of oil based furniture polishes, wood preservatives, or cleaning sprays may cause the rubber 'feet' to soften, and leave marks or a rubber residue on the furniture.

To prevent any damage to your furniture we strongly recommend that you purchase small self-adhesive felt pads, available at hardware stores and home improvement centers everywhere, and apply these pads to the bottom of the rubber 'feet' before you place the product on fine wooden furniture.







## WELCOME

Thank you for purchasing JENSEN JiSS-115 Docking System.

Before operating the unit, please read this manual thoroughly and retain it for future reference.

## LOCATION OF CONTROLS

1. FUNCTION BUTTON
2. POWER / STANDBY BUTTON 
3. VOLUME CONTROL
4. CARRYING HANDLE
5. CD DOOR
6. FM STEREO INDICATOR
7. LCD DISPLAY
8. CD DOOR OPEN / CLOSE AREA
9. PLAY / PAUSE  BUTTON
10. B-SKIP  BUTTON
11. F-SKIP  BUTTON
12. PLAY MODE BUTTON
13. PROGRAM/CLOCK-ADJ. BUTTON
14. STOP  BUTTON
15. TUNING CONTROL
16. BAND SWITCH
17. SPEAKER
18. iPod CONNECTOR
19. AC SOCKET
20. BATTERY COMPARTMENT
21. TELESCOPIC ANTENNA
22. AUX. IN JACK

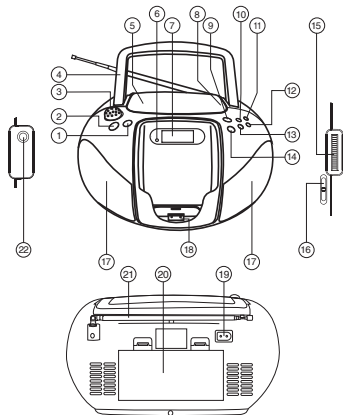

## GETTING STARTED

### Unpacking the Docking System

Please save all the original packaging. It provides the safest way to transport your unit.

## POWER SOURCE

This Portable Docking System is designed to operate on 120V~ 60Hz AC power or with 8 'C' size (UM-2) batteries (Not included).

## CAUTION:

Mains plug should be regularly checked for any damage. If it is damaged do not operate the unit, seek advice from a qualified service technician or contact the distributor of this product via the telephone number at the back of this instruction manual.

Do not attempt to operate the unit on any other power source as this could cause damage to the unit and void your warranty.

## A. BATTERY OPERATION

**Note:** For best performance and longer operating time, we recommend the use of alkaline-type batteries.

1. Remove the Battery Door on the back of the unit.
2. Follow the marked polarities and install 8 "C" size (UM-2) batteries.
3. Replace the Battery Door.

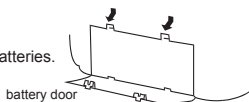

**IMPORTANT:** Be sure that the batteries are installed correctly.  
Wrong polarity may damage the unit.

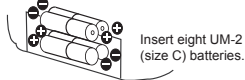

## BATTERY CARE

- (a) Do not mix old and new batteries.
- (b) Do not mix alkaline, standard (carbon-zinc) or rechargeable (nickel-cadmium) batteries.
- (c) If the unit is not to be used for an extended period of time, remove all batteries. Old or leaking battery can cause damage to the unit and may void the warranty.
- (d) Do not dispose batteries in fire. Batteries may leak or explode.

## B. AC POWER CONNECTION

1. Insert one end of the power cord to the AC Socket on the back of the Docking System. The internal battery source will automatically be disconnected
2. Connect the power cord to an AC 120V~ 60Hz power outlet.

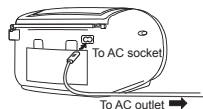

## TURNING POWER ON/OFF AND SELECTING FUNCTION

1. Turn the System to ON and OFF by pressing the POWER / STANDBY  Button.



2. The function is selected cyclically by pressing the FUNCTION Button:

CD → iPod → AUX → TUNER



## ADJUSTING THE SOUND LEVEL

To Adjust the Volume Level

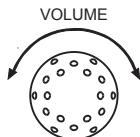



## CLOCK SETTING

The clock can only be adjusted and displayed in STANDBY mode.

1. Press the PROGRAM / CLOCK-ADJ. Button,
2. Press F-SKIP▶▶▶ or B-SKIP◀◀◀ to select 12 or 24 hour format.
3. Press the PROGRAM / CLOCK-ADJ. Button to confirm.

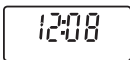

PROGRAM / CLOCK-ADJ.

- The Hour digit flashes.
4. Press F-SKIP▶▶▶ or B-SKIP◀◀◀ to adjust the hour.
  5. Press the PROGRAM / CLOCK-ADJ. Button to enter when the desired hour is shown.
- The Minute digit flashes.
6. Press F-SKIP▶▶▶ or B-SKIP◀◀◀ to adjust the minute.
  7. Press the PROGRAM / CLOCK-ADJ. Button again to confirm when the correct time is shown in the Display.

## LISTENING TO THE RADIO

1. Press the POWER / STANDBY ⏻ Button once to turn on the System. The LCD backlight will light.
2. Press the FUNCTION Button to select TUNER mode.

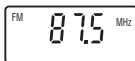
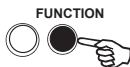

3. Set the BAND SWITCH to "AM" or "FM" for the desired radio band.

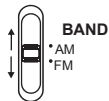

4. Tune to your desired station by turning the TURNING CONTROL.  
The frequency of the tuned station will be displayed on the LCD Display.  
The FM STEREO Indicator will light when a FM stereo program is received.

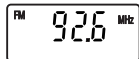
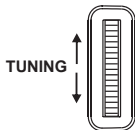

5. Adjust the Volume Control to obtain the desired sound level from the Built-in Speakers.
6. To turn the System off, press the POWER / STANDBY ⏻ Button again. The LCD backlight will go off.







## TIPS FOR BEST RADIO RECEPTION

1. To insure maximum FM tuner reception, the Telescopic Antenna should be fully extended and rotated to obtain the best possible station reception.
2. The AM antenna is built into the unit. When tuning in AM reception, be sure to place the unit in a vertical position. To obtain the best AM reception, try repositioning the unit until the best station reception is obtained.

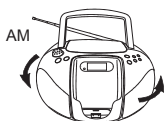
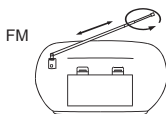

## CD PLAYER OPERATION

**Note:** This CD player plays not only commercial CDs, but also self-compiled CD-R/RW discs. Do not attempt to play CD-ROM, CDI, VCD, DVD or computer CDs.

### Notes on CD-R/RW Discs

- Because of non-standardized format definition/production of CD-R/RW, playback quality & performance are not guaranteed.
- Manufacturer is not responsible for the playability of CD-R/RW due to recording conditions such as PC performance, writing software, media ability, etc.
- Do not attach a label or seal to either side of the CD-R/RW disc. It may cause a malfunction.

1. Press the POWER / STANDBY Button once to turn on the System. The LCD backlight will light.
2. Press the FUNCTION Button to select CD mode.
3. Open the CD DOOR by pressing the CD DOOR where OPEN/CLOSE is shown.
4. Carefully place an audio CD with its label side upward in the CD compartment and close the CD Door.
5. The LCD Display will briefly display flashing "--" and then the total number of tracks on the CD will appear in the LCD Display after a few seconds.
6. Press the PLAY/PAUSE Button to start playback. The Play Indicator "▶" will light and the CD will start playing from the first track.
7. Adjust the VOLUME CONTROL to obtain the desired sound level from the Built-in Speakers.



### TO INTERRUPT PLAYBACK

8. To suspend playing, press the PLAY/PAUSE Button once. The Play Indicator will flash.
9. To resume playing, press the PLAY/PAUSE Button again. The Play Indicator "▶" will light steadily in the LCD Display.





## SKIPPING AND SEARCHING TRACKS

10. You can choose to play your favorite track directly by pressing either the B-SKIP or F-SKIP Buttons. The LCD Display will indicate the track number of the selected track.
11. To locate a particular passage within a track, keep the B-SKIP F-SKIP Buttons depressed until it is found.



## REPEATING PLAYBACK

12. To repeat a particular track, press the PLAY MODE Button once. The REPEAT Indicator appears in the LCD Display.



13. To repeat the entire CD, press the PLAY MODE Button twice. The REPEAT ALL Indicator lights in the LCD Display.



14. To cancel the REPEAT function, press the PLAY MODE Button two more times until the REPEAT / REPEAT ALL Indicator disappears from the LCD Display.

## RANDOM PLAYBACK

15. To play the tracks in random, in Stop mode press the PLAY MODE Button three times. The Random Indicator will appear in the Display.

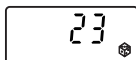

16. Press the PLAY/PAUSE Button once. A track is picked at random and playback starts.

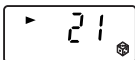

17. To cancel the random function, press the PLAY MODE Button again.
18. To stop playback, press the STOP Button once.
19. When you wish to turn the System off, press the POWER / STANDBY Button. The LCD backlight goes off.

## CD PROGRAMMED PLAY

This function allows the tracks to be played in a programmed sequence.

NOTE: Program can only be set in STOP mode. Up to 20 tracks can be programmed.

1. In CD stop mode, press the PROGRAM Button once. "PROGRAM" will appear and Program No. "P01" will appear briefly and then change to "00" and blink together with "PROGRAM" in the LCD Display to prompt for input.





- Press the B-SKIP ◀◀ or F-SKIP ▶▶ Buttons to select the song to be programmed.  
For example track 5 is selected.
- Press the PROGRAM Button again to store the selection. The Program No. will advance to "P02" and then change to "00" and blink to prompt for another input.
- Press the B-SKIP ◀◀ or F-SKIP ▶▶ Buttons to select the next song to be programmed.
- Press the PROGRAM Button to store the second selection. You may repeat steps #2 - #4 to program as many as 20 tracks.
- Press the CD PLAY/PAUSE ▶▶ Button to start playback in the programmed sequence.

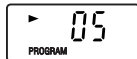

- After all the programmed tracks have been played, the player stops but the programmed tracks remain in the memory.
  - Press the PROGRAM Button followed by the PLAY/PAUSE ▶▶ Button to begin programmed playback again.
- To cancel programmed play, in Stop mode press the STOP ■ Button once or open the CD DOOR.
  - To turn the System off, press the POWER / STANDBY ⏻ Button. The LCD backlight will go off.

## DOCKING YOUR iPod

- Insert the universal adaptor for the type of iPod you will dock.
- To remove the adaptor to exchange for the others, press at the back of the adaptor and pull it upward.
- Press the POWER / STANDBY ⏻ Button once to turn on the System.  
The LCD backlight will light.
- Press the FUNCTION Button to select iPod mode.

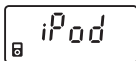

- Your iPod can now be inserted onto the iPod connector by aligning the connector on the bottom of the iPod onto the connector in the docking bay.  
**Note:** Please be careful when seating the iPod into the docking to avoid damaging the 30-pin connector on the iPod or in the Docking System.
- The iPod will start playing automatically and also start charging.  
**Note:** The iPod will only be charged when the System is powered by AC.
- Select the previous or next music tracks by pressing the B-SKIP ◀◀ or F-SKIP ▶▶ Buttons repeatedly, and press the PLAY/PAUSE ▶▶ Button to play or pause.  
**Note:** The System's LCD cannot show any music information (e.g. song name) of your iPod.  
Please view the music information through your iPod display.
- Adjust the sound level using the VOLUME CONTROL.  
**Note:** The volume level cannot be adjusted using the volume control on your iPod after docking.
- To remove the iPod from the unit, press and hold the PLAY/PAUSE ▶▶ Button on the System for a few seconds or simply press the STOP ■ Button once to switch off the device and then gently remove it from the dock connector.
- To turn the Docking System off, press the POWER / STANDBY ⏻ Button.  
The LCD backlight will go off.



## AUX OPERATION

You can playback your favorite music from your MP3 player or a portable digital audio player using the AUX IN jack.

1. Connect the headphone jack of your external device and the AUX IN Jack located on the left side of this Docking System.  
(The connection cable is not included.)
2. Press the POWER / STANDBY  Button once to turn on the System.  
The LCD backlight will light.
3. To enter the AUX function mode, press the FUNCTION Button to select AUX mode.

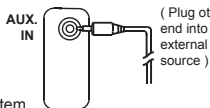

4. Start to playing your MP3 player or other audio device.
5. Slowly adjust both the volume controls on your Docking System and the external device.
6. Turn off your MP3 player or other audio device etc. and unplug the AUX IN jack when finish listening.
7. To turn the Docking System off, press the POWER / STANDBY  Button. The LCD backlight will go off.

## CARE AND MAINTENANCE

1. Avoid operating your unit under direct sunlight or in hot, humid or dusty places.
2. Keep your unit away from heating appliances and sources of electrical noise such as fluorescent lamps or motors.
3. If drop-outs or interruptions occur in the music during CD play, or if the CD fails to play at all, its bottom surface may require cleaning.  
Before playing, wipe the disc from the center outwards with a good soft cleaning cloth.
4. Unplug the unit from the electrical power outlet immediately in case of malfunction.



### Cleaning the Unit

- To prevent fire or shock hazard, disconnect your unit from the AC power source when cleaning.
- The finish on the unit may be cleaned with a dust cloth and cared for as other furniture.  
Use caution when cleaning and wiping the plastic parts.
- If the cabinet becomes dusty wipe it with a soft dry dust cloth. Do not use any wax or polish sprays on the cabinet.
- If the front panel becomes dirty or smudged with fingerprints it may be cleaned with a soft cloth slightly dampened with a mild soap and water solution. Never use abrasive cloths or polishes as these will damage the finish of your unit.

**CAUTION:** Never allow any water or other liquids to get inside the unit while cleaning.

## TROUBLESHOOTING GUIDE

If you experience difficulties in the use of this Docking System, please check the following or call 1-800-777-5331 for Customer Service.

Symptom	Possible Problem	Solution
Unit does not respond (no power)	AC Cord is not plugged properly into a wall outlet or the connector is not plugged into the AC Socket on the back of the System	Re-plug the AC Cord into the wall outlet and the connector into AC Socket on the System.
	Wall outlet is not functioning.	Plug another device into the same outlet to confirm the outlet is working.
Noise or sound distorted on AM or FM broadcast	Station not tuned properly for AM or FM. <b>FM:</b> Telescopic antenna is not fully extended. <b>AM:</b> The bar antenna is not positioned correctly	Retune the AM or FM broadcast station. <b>FM:</b> Fully extend the FM telescopic antenna. <b>AM:</b> Reposition the unit until the best reception is obtained. Undock your iPod.
AM or FM no sound	Unit not in TUNER function mode. Volume set at minimum	Press Function Button to select TUNER Increase Volume
Cannot dock iPod properly	Using a wrong iPod insert	Make sure the dock insert is the proper fit for your iPod.
	iPod is not installed properly.	Remove your iPod from the dock and check for any obstruction on the connectors in the dock and on your iPod, then reseat it in the dock.
iPod does not respond to the unit.	iPod is not installed properly.	Remove your iPod from the dock and check for any obstruction on the connectors in the dock and on your iPod, then reseat it in the dock.
	Your iPod software is too old	Update software on your iPod. For details, please visit <a href="http://www.apple.com/ipod/download">http://www.apple.com/ipod/download</a>
CD player will not play	Unit not in CD function mode. CD is installed incorrectly. If the CD is self-compiled, the media used may not be compatible with the player.	Select CD function mode. Insert CD with label side up. Use better quality blank media and retest.
CD skips while playing	Disc is dirty or scratched.	Wipe CD with clean cloth or use another disc.
Intermittent sound from CD Player	Dirty or defective disc Dirty pick up lens  Player is subject to excessive shock or vibration	Clean or replace the defective disc Use a CD-lens cleaning disc to clean the lens Relocate the player away from shock or vibration

iPod is a trademark of Apple Inc., registered in the U.S. and other countries.

"Made for iPod" means that an electronic accessory has been designed to connect specifically to iPod and has been certified by the developer to meet Apple performance standards.

Apple is not responsible for the operation of this device or its compliance with safety and regulatory standards

  
**90 DAY LIMITED WARRANTY AND SERVICE**  
VALID IN THE U.S.A ONLY

SPECTRA MERCHANDISING INTERNATIONAL, INC. warrants this unit to be free from defective materials or factory workmanship for a period of 90 days from the date of original customer purchase and provided the product is utilized within the U.S.A. This warranty is not assignable or transferable. Our obligation under this warranty is the repair or replacement of the defective unit or any part thereof, except batteries, when it is returned to the SPECTRA Service Department, accompanied by proof of the date of original consumer purchase, such as a duplicated copy of a sales receipt.

You must pay all shipping charges required to ship the product to SPECTRA for warranty service. If the product is repaired or replaced under warranty, the return charges will be at SPECTRA's expense. There are no other express warranties other than those stated herein.

This warranty is valid only in accordance with the conditions set forth below:

1. The warranty applies to the SPECTRA product only while:
  - a. It remains in the possession of the original purchaser and proof of purchase is demonstrated
  - b. It has not been subjected to accident, misuse, abuse, improper service, usage outside the descriptions and warnings covered within the owner's manual or non-SPECTRA approved modifications
  - c. Claims are made within the warranty period
2. This warranty does not cover damage or equipment failure caused by electrical wiring not in compliance with electrical codes or SPECTRA owner's manual specifications, or failure to provide reasonable care and necessary maintenance as outlined in the owner's manual.
3. Warranty of all SPECTRA products applies to residential use only and is void when products are used in a nonresidential environment or installed outside the United States.

This warranty gives you specific legal rights, and you may also have other rights which vary from state to state. TO OBTAIN SERVICE please remove all batteries (if any) and pack the unit carefully and send it prepaid by insured parcel post or UPS to SPECTRA at the address shown below. IF THE UNIT IS RETURNED WITHIN THE WARRANTY PERIOD shown above, please include a proof of purchase (dated cash register receipt) so that we may establish your eligibility for warranty service and repair of the unit without cost. Also include a note with a description explaining how the unit is defective. A customer service representative may need to contact you regarding the status of your repair, so include your name, address, phone number and e-mail address to speed the process.

IF THE UNIT IS OUTSIDE THE WARRANTY PERIOD, please include a check for **\$25.00** to cover the cost of repair, handling and return postage. All out of warranty returns must be sent prepaid.

It is recommended that you contact SPECTRA first at 1-800-777-5331 or by e-mail at [info@spectrainl.com](mailto:info@spectrainl.com) for updated information on the unit requiring service. In some cases the model you have may be discontinued and SPECTRA reserves the right to offer alternative options for repair or replacement.

SPECTRA MERCHANDISING INTERNATIONAL, INC.  
4230 North Normandy Avenue,  
Chicago, IL60634, USA.  
1-800-777-5331

To register your product, visit the link below on the website to enter your information.  
<http://www.spectrainl.com/wform.htm>